

**FAMILY WEATHER STATION**  
**Instruction Manual**

**INTRODUCTION:**

Congratulations on purchasing this state-of-the-art weather station as an example of excellent design and innovative measuring technique. Featuring time, date, calendar, weather forecast, wind direction and speed, rainfall, outdoor temperature and outdoor humidity, air pressure and various alarm settings for different weather conditions, this weather station will provide you with various weather information and weather forecast. Pages after pages, you will discover that the operation of your weather station is really simple!



## FEATURES:

### The Multifunctional Weather Station

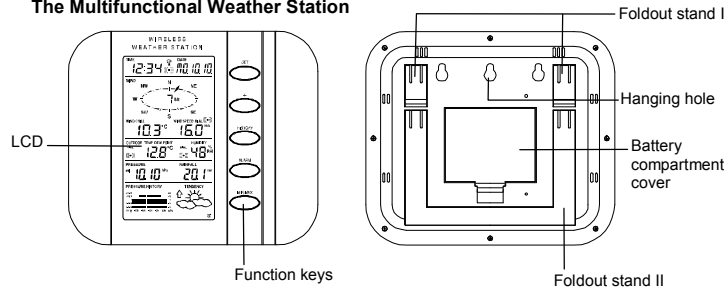

- Time display (manual setting)
- 12/24 hour time display
- Calendar display (weekday, date, month, year)
- Time alarm function
- Weather forecasting function with three weather icons and weather tendency indicator
- Outdoor temperature display in °C/°F
- Outdoor Humidity display as RH%
- Max / Min value of outdoor temperature and humidity display with time & date of recording
- Low/High outdoor temperature and humidity alarm

- Relative air pressure displayed in hPa or inHg
- Air pressure tendency indicator for the past 12 hour (bargraph format)
- LCD contrast selectable
- Low battery indicator
- Wind direction displayed in 16 steps
- Wind speed displayed in km/h, mph or m/s, and Beaufort scale
- Wind chill displayed in °C of °F
- Max wind speed displayed with time & date of recording
- High alarm function for wind speed
- Manual reset of outdoor temperature/ humidity, pressure and windchill data
- Total rainfall displayed in mm or inch
- Storm warning alarm
- Buzzer on/ off selectable
- Storage of 200 sets of history weather data recorded in three-hour intervals
- Wireless transmission at 868 MHz
- Transmission range up to 100 metres

#### **The Thermo-hygroTransmitter**

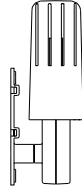

- Remote transmission of the outdoor temperature and humidity to the Weather Station at 868 MHz
- Showerproof casing
- Wall mounting case (To be mounted in a sheltered place. Avoid direct rain and sunshine.)

**The Wind sensor**

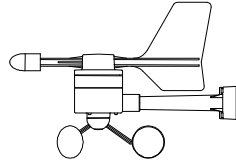

- Connected to the thermo-hygro transmitter by cable
- Can be installed onto a mast or a horizontal panel

**THE RAIN SENSOR**

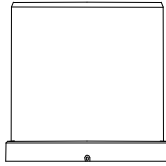

- Connected to the thermo-hygro transmitter by cable
- To be mounted onto a horizontal panel

**SETTING UP:**

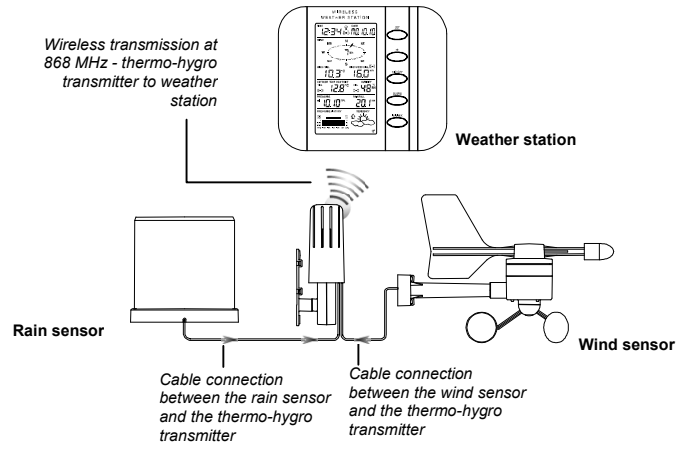

**Note:**

When putting the Weather Station into operation, it is important to perform in close proximity (e.g. on a table) a complete wiring and set-up of the system. This step is

important to test all components for correct function before placing and mounting them at their final destinations (See **POSITIONING** below)

1. Unwind the cables of the Rain and the Wind sensors. Connect the Rain and the Wind sensors to the Thermo-hygro transmitter by plugging the connector heads of the two sensors into the appropriate sockets of the Thermo-hygro transmitter.

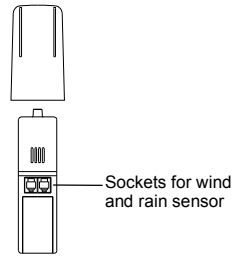

2. First insert the batteries into the Thermo-hygro transmitter (see **HOW TO INSTALL AND REPLACE THE BATTERIES INTO THE THERMO-HYGRO TRANSMITTER** below).
3. Then insert the batteries into the Weather Station (see **HOW TO INSTALL AND REPLACE THE BATTERIES INTO THE WEATHER STATION** below). Once the batteries are installed, all segments of the LCD will light up briefly and a short signal tone will be heard. It will then display the time as 0:00, the

date as 1.1.05, the weather icons, and air pressure value. "- -" will be shown for outdoor data.

4. Afterwards, the Weather Station will start receiving data from the transmitter. The outdoor temperature, humidity windchill and wind speed should then be displayed on the Weather Station. If this does not happen after 30 seconds, the batteries will need to be removed from both units. You will have to start again from step 1.
5. You may then check all cables for correct connection and all components for correct function by manually turning the wind-gauge, moving the weather-vane, tilting the rain sensor to hear the impact of the internally moving seesaw, etc (see **POSITIONING** below).
6. Time and date shall be manually set (see **MANUAL SETTING** below).
7. After the Weather Station has been checked for correct function with regard to the above points and found fit, the initial set up of the weather station system is finished and the mounting of the system components can take place. It must be ensured however that all components work properly together at their chosen mounting or standing locations. If e.g. there appear to be problems with the 868 MHz radio transmission, they can mostly be overcome by slightly changing the mounting locations.

**Note:**

The radio communication between the receiver and the transmitter in the open field reaches distances of max 100 metres, provided there are no interfering obstacles such as buildings, trees, vehicles, high voltage lines, etc.

8. Radio interferences created by PC screens, radios or TV sets can in some cases entirely cut off radio communication. Please take this into consideration when choosing standing or mounting locations.

**Note :**

- After batteries are installed in transmitter, user shall also power up the weather station to receive the signal from the transmitter as soon as possible. If the weather station is powered after about more than five hours the transmitter is powered, the weather station will never receive signal successfully from this transmitter. In this case, user will need to reinstall the batteries from the transmitter to redo setting-up procedures.
- After batteries are installed, there will be synchronisation between weather station and the receiver. At this time, the signal reception icon will be blinking. When the signal is successfully received by the weather station, the icon will be switched on. (If not successful, the icon will not be shown in LCD.) So the user can easily see whether the last reception was successful (icon on) or not (icon off). On the other hand, the short blinking of the icon shows that a reception is being done now.

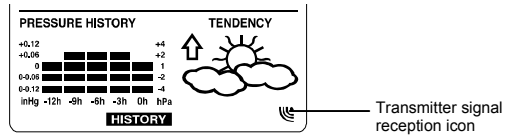



### HOW TO INSTALL AND REPLACE THE BATTERIES INTO THE WEATHER STATION

The Weather Station works with 3 x AA, IEC LR6, 1.5V batteries. When the batteries need to be replaced, the low battery symbol will appear on the LCD.

To install and replace the batteries, please follow the steps below:

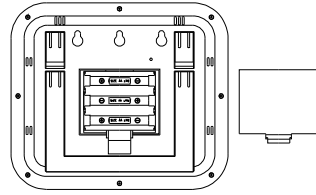

1. Remove the battery compartment cover.
2. Insert the batteries observing the correct polarity (see the marking in the battery compartment).
3. Replace the battery cover.

### HOW TO INSTALL AND REPLACE THE BATTERIES INTO THE THERMO-HYGRO TRANSMITTER

The outdoor Thermo-hygro transmitter works with 2 x AA IEC LR6, 1.5V batteries. To install and replace the batteries, please follow the steps below:

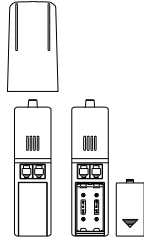

1. Uninstall the rain cover of the transmitter.
2. Remove the battery compartment cover.
3. Insert the batteries, observing the correct polarity (see the marking in the battery compartment).
4. Replace the battery cover and the rain cover onto the unit.

**Note:**

In the event of changing batteries in any of the units, all units need to be reset by following the setting up procedures. This is because a random security code is assigned by the transmitter at start-up and this code must be received and stored by the Weather Station in the first 30 seconds of power being supplied to it.

**BATTERY CHANGE:**

It is recommended to replace the batteries in all units on an annual basis to ensure optimum accuracy of these units.



**Please participate in the preservation of the environment. Return used batteries to an authorised depot.**



**Note:**

The stored History record will not be kept after the battery change is done on the weather station.

**FUNCTION KEYS:**

**Weather Station:**

The Weather Station has five easy-to-use function keys.

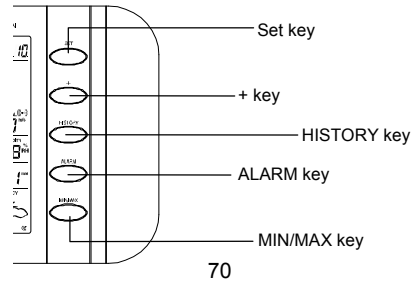

**SET key**

- Press to enter manual setting modes: LCD contrast, Manual time setting, 12/24 hour time display, Calendar setting, °C/ °F temperature unit, Wind speed unit, Rainfall unit, Pressure unit, Relative pressure reference setting, Weather tendency threshold setting, Storm warning threshold setting and Storm Alarm On/ Off setting
- In normal display mode, press and hold to switch on/ off the Buzzer
- In the weather alarm setting mode, press and hold to adjust different alarm value and switch the alarm On/ Off
- Press to activate the reset mode when max or min record is shown
- Stop the alarm during the time alarm or weather alarm ringing

**+ key**

- Press to change the calendar display to the preset alarm time, date, weekday + date or second in the time display
- Press to adjust (increase) the level of different settings
- Stop the alarm during the time alarm or weather alarm ringing
- Press to confirm to reset the max/min record

**HISTORY key**

- Press to display the weather data history records
- Stop the alarm during the time alarm or weather alarm ringing
- Press to exit manual setting mode and alarm setting mode

**ALARM key**

- Press to enter the time alarm and weather alarm setting mode
- Confirm particular alarm setting

- Press to exit the manual setting mode
- Stop the alarm during the time alarm or weather alarm ringing
- Press to exit max/ min record display mode

**MIN/MAX key**

- Press to display minimum and maximum records of various weather data
- Press to adjust (decrease) the level of different settings
- Stop the alarm during the time alarm or weather alarm ringing

**LCD SCREEN**

The LCD screen is split into five sections displaying the following information:

1. Time and date
2. Wind data
3. Outdoor temperature and humidity,
4. Air pressure and Rainfall data
5. Air pressure history and Weather forecast.

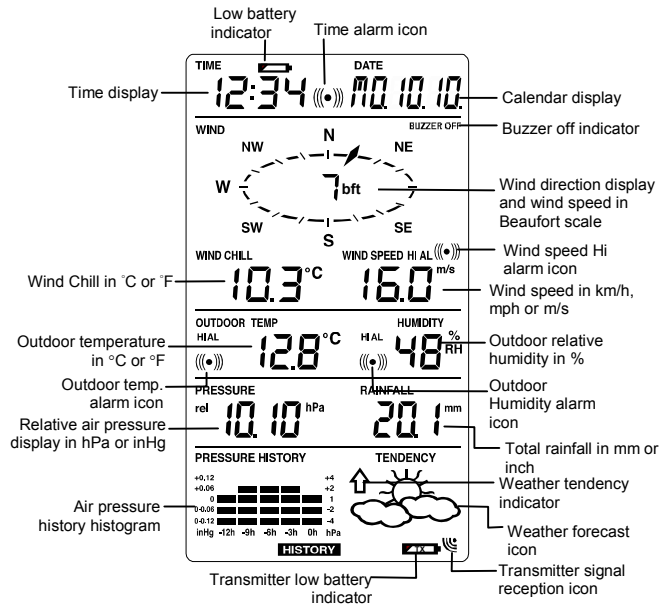

### MANUAL SETTING:

The following manual settings can be changed once the SET key is pressed:

- LCD contrast setting
- Manual time setting
- 12/24 hour time display
- Calendar setting
- °C/ °F temperature unit setting
- Wind speed unit
- Rainfall unit setting
- Air pressure unit setting
- Relative pressure reference value setting
- Weather tendency threshold value
- Storm warning threshold value
- Alarm On/ Off setting

### LCD CONTRAST SETTING

Lcd 5 ——— Digit flashing

---

The LCD contrast can be set within eight levels, from "LCD 1" to "LCD 8" (default setting is LCD 5):

1. Press the SET key, the contrast level digit will start flashing.
2. Use the + or MIN/MAX key to adjust the level of contrast.
3. Confirm with the SET key and enter the **MANUAL TIME SETTING**.

**MANUAL TIME SETTING:**

You then may manually set the time of the clock by following the steps below:



1. The hour digit will start flashing.
2. Use the + or MIN/MAX key to set the hour.
3. Press the SET key to switch to the minutes. The minute digit will start flashing.
4. Use the + or MIN/MAX key to set the minute.
5. Confirm the time with the SET key and enter the **12/24 HOUR TIME DISPLAY SETTING**.

**12/24 HOUR TIME DISPLAY SETTING:**

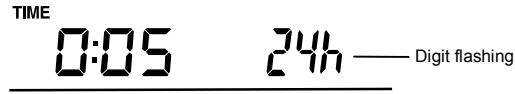

The time can be set to view as 12-hour or 24-hour format. The default time display mode is "24-h". To set to "12-h" time display:

1. Use the + or MIN/MAX key to toggle the value.



2. Confirm with the SET key and enter the **CALENDAR SETTING**.

**CALENDAR SETTING:**

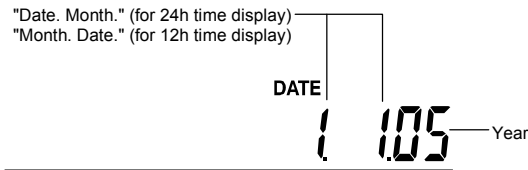

The date default of the Weather Station is 1. 1. of year 2005. The date can be set manually by proceeding as follows.

1. The year digit starts flashing.
2. Use the + or MIN/MAX key to set the year. The range runs from "00" (2000) to "99" (2099).
3. Press the SET key to confirm the year and enter the month setting. The month digit will start flashing.
4. Use the + or MIN/MAX key to set the month.
5. Press the SET key to confirm the month and enter the date setting mode. The date digit will start flashing.
6. Use the + or MIN/MAX key to set the date.
7. Confirm all calendar settings with the SET key and enter the **°C/°F TEMPERATURE UNIT SETTING**.

## °C/°F TEMPERATURE UNIT SETTING

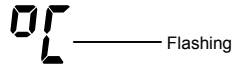

The temperature display can be selected to show temperature data in °C or °F. (default °C)

1. The temperature unit is flashing
  2. Use the + or MIN/MAX key to toggle between “°C” or “°F”.
- Confirm with the SET key and enter the **WIND SPEED UNIT SETTING**

## WIND SPEED UNIT SETTING

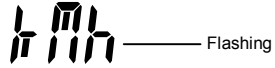

The wind speed unit can be set as km/h (kilometre per hour), mph (mile per hour) or m/s (metre per second). The default unit is km/h.

1. Use the + or MIN/MAX key to toggle between the unit “km/h”, “mph” or “m/s”
2. Confirm with the SET key and enter the **RAINFALL UNIT SETTING**.

## RAINFALL UNIT SETTING

 Flashing

---

The total rainfall unit can be set as mm or inch. The default unit is mm.

1. Use the + or MIN/MAX key to toggle between the unit "mm" or "Inch"
2. Confirm the unit with the SET key and enter the **RELATIVE AIR PRESSURE UNIT SETTING**

## RELATIVE AIR PRESSURE UNIT SETTING

 Flashing

---

The relative air pressure can be set as hPa or inHg. The default unit is hPa.

1. Use the + or MIN/MAX key to toggle between the unit "hPa" or "inHg"
2. Confirm the unit with the SET key and enter the **RELATIVE PRESSURE REFERENCE VALUE SETTING**.

## RELATIVE PRESSURE REFERENCE VALUE SETTING

**Note:**

The default reference pressure value of the barometer is 1013 hPa when batteries are first inserted. *For an exact measurement, it is necessary to first adjust the barometer to your local relative air pressure (related to elevation above sea level).* Ask for the current atmospheric pressure of your home area (local weather service, www, optician, calibrated instruments in public buildings, airport).

The relative air pressure can be manually set to another value within the range of 919 to 1080 hPa (27.17 to 31.90 inHg) for a better reference.

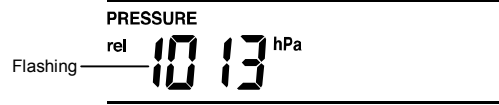

1. The current relative pressure value will start flashing
2. Use the + or MIN/MAX key to increase or decrease the value. Keep holding the key will allow the value to increase faster.
3. Confirm with the SET key and enter the **WEATHER TENDENCY THRESHOLD VALUE SETTING**.

**Note:**

This calibration facility is useful for those users living at various elevations above sea level, but wanting their air pressure display to be based on sea level elevation.

## WEATHER TENDENCY THRESHOLD VALUE SETTING

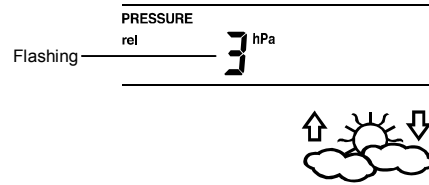

You may select a definite switching threshold value, 2 hPa to 4 hPa for the change in the display of weather icons. This represents the "sensitivity" of the weather forecast (the smaller the value selected, the more sensitive the weather forecast). The default value is 3 hPa.

1. The threshold value will start flashing
2. Use the + or MIN/MAX key to select the value.
3. Confirm with the SET key and enter the **STORM WARNING THRESHOLD VALUE SETTING**.

### STORM WARNING THRESHOLD VALUE SETTING

You may also define a switching threshold value for the Storm warning display at a decrease of air pressure from 3 hPa to 9 hPa over 6 hours (Default 5 hPa).

Flashing ———— **PRESSURE**  
rel **5** hPa



1. The threshold value will start flashing.
2. Use the + or MIN/MAX key to select the value.
3. Confirm with the SET key and enter the **STORM ALARM ON/ OFF SETTING**.

#### **STORM ALARM ON/ OFF SETTING**

You may also choose to switch On or Off the acoustic Storm warning alarm (Default OFF).

1. The digit "AOF" will start flashing.
2. Use the + key to switch On or Off the alarm. ("AOF" = OFF; "AON" = On)
3. Confirm with the SET key and the normal display mode will be shown.

Flashing ———— **PRESSURE**  
rel **AOF**

**Note:**

In case a storm warning alarm is activated, the downward weather tendency arrow will

be flashing. (also see clause **WEATHER TENDENCY INDICATOR** below)

#### **TO EXIT THE MANUAL SETTING MODE**

To exit the manual setting anytime during the manual setting modes, press the ALARM key (or HISTORY key) anytime or wait for the automatic timeout. The mode will return to the normal time display.

#### **TIME ALARM SETTING**

The alarm time can be set by the use of the ALARM and SET key.

1. Press the ALARM key once. The "ALARM" icon and time digits are shown at the top right of the LCD.

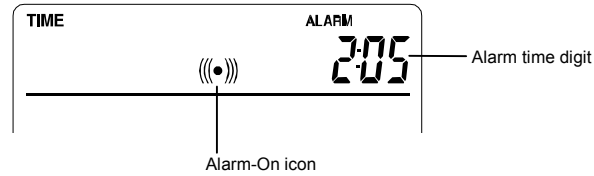

2. Press and hold the SET key for about two seconds. The hour digit of the alarm time will start flashing. Press the + or MIN/MAX key to set the hour of the alarm time.
3. Press the SET key to confirm and advance to the minute setting. The minute digit will be flashing.

4. Press the + or MIN/MAX key to set the minute of the alarm time. Press the ALARM key to confirm. Wait for about 30 seconds and the display will return to normal display mode automatically.
5. In the normal display mode, press the ALARM once key to go to the time alarm setting mode again. Then press shortly the SET key to switch on or off the time alarm. (The showing of the icon [((•))] means that the time alarm is switched on.)
6. Press the HISTORY key or wait for about 30 seconds and the display will return to normal display mode automatically.

**Note:**

The alarm ringing duration is two minutes. To stop the alarm, press any key during the alarm ringing.

**WEATHER ALARM OPERATIONS**

The Weather alarms are settable for when certain weather conditions are met according to your requirements. For example, you can set the thresholds for the outdoor temperature to +40°C (high) and -10°C (low), whilst only enabling the high alarm and disabling the low alarm (i.e. temperatures <-10°C won't trigger alarm, but temperatures >+40°C will).



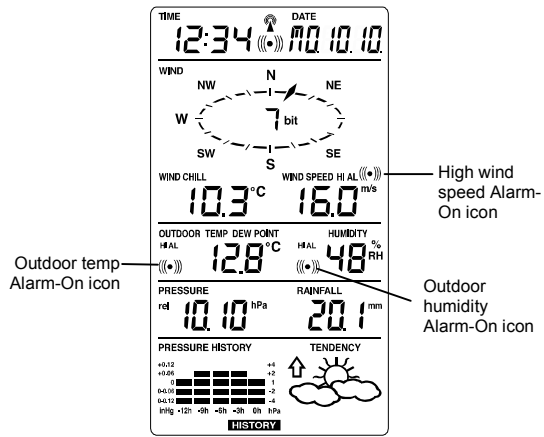

The Weather Station can be set to alert when a specific weather condition is reached.

The following Weather Alarm settings can be adjusted in the ALARM setting mode.

- High outdoor temperature alarm
- Low outdoor temperature alarm

- High outdoor humidity alarm
- Low outdoor humidity alarm
- High wind speed alarm

**Default alarm values:**

Temperature	Low	0°C
	High	40°C
Relative Humidity	Low	45%
	High	70%
Wind speed	High	100 km/h

**HIGH AND LOW OUTDOOR TEMPERATURE ALARM SETTING**

**Note:**

The High and Low outdoor temperature alarm can be set On/ Off independently, according to your needs.

**Set the Outdoor temperature alarm value (High or Low alarm value) :**

1. In the normal display mode, press the ALARM key twice. The High Outdoor Temperature alarm display will be shown.

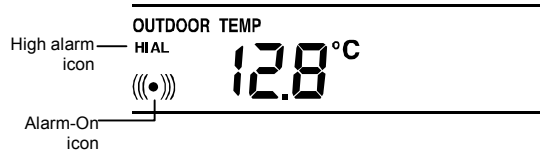

2. Press and hold the SET key for about two seconds. The temperature digit will start flashing. Press the + or MIN/MAX key to set the high outdoor temp alarm value. (Keep holding the key will allow the value to increase faster.)
3. Press the ALARM key to confirm the setting. The digit will stop flashing. Press the SET key to switch on or off the alarm. (The showing of the icon [((•))] means that the alarm is switched on.)
4. Press the ALARM key once. The Low Outdoor Temperature alarm display will be shown.
5. Press and hold the SET key for about two seconds. The temperature digit will start flashing. Press the + or MIN/MAX key to set the low outdoor temp alarm value. (Keep holding the key will allow the value to increase faster.)
6. Press the ALARM key to confirm the setting. The digit will stop flashing. Press the SET key to switch on or off the alarm. (The showing of the icon [((•))] means that the alarm is switched on.)
7. Press the HISTORY key or wait for about 30 seconds and the display will return to normal display mode automatically.

In case the temperature value meets the condition for high alarm or low alarm, the value will be blinking, along with the corresponding icon ("HI AL"/ "LO AL"). And the buzzer will ring for two minutes. User then may press any key to stop the ring. User may quit the alarm setting and return to the normal display mode by pressing the HISTORY key.

## HIGH AND LOW OUTDOOR HUMIDITY ALARM SETTING

**Note:**

The High and Low outdoor humidity alarm can be set On/ Off independently according to your needs.

**Set the Outdoor humidity alarm value (High or Low alarm value):**

1. In the normal display mode, press the ALARM key four times. The High Outdoor Humidity alarm display will be shown.



2. Press and hold the SET key for about two seconds. The humidity digit will start flashing. Press the + or MIN/MAX key to set the high outdoor humidity alarm value.
3. Press the ALARM key to confirm the setting. The digit will stop flashing. Press the SET key to switch on or off the alarm. (The showing of the icon [((•))] means that the alarm is switched on.)
4. Press the ALARM key once. The Low Outdoor Humidity alarm display will be shown.
5. Press and hold the SET key for about two seconds. The humidity digit will start flashing. Press the + or MIN/MAX key to set the low outdoor humidity alarm value.

6. Press the ALARM key to confirm the setting. The digit will stop flashing. Press the SET key to switch on or off the alarm. (The showing of the icon [((•))] means that the alarm is switched on.)
7. Press the HISTORY key or wait for about 30 seconds and the display will return to normal display mode automatically.

In case the humidity value meets the condition for high alarm or low alarm, the value will be blinking, along with the corresponding icon ("HI AL"/ "LO AL"). And the buzzer will ring for two minutes. User may press any key to stop the sound.

#### WIND SPEED ALARM SETTING

The High wind speed alarm can be set by following the steps below.

1. In the normal display mode, press the ALARM key six times. The High wind speed alarm display will be shown.

WIND SPEED HI AL [((•))]  
16.0 m/s

---

2. Press and hold the SET key for about two seconds. The wind speed digit will start flashing. Press the + or MIN/MAX key to set the high wind speed alarm value.
3. Press the ALARM key to confirm the setting. The digit will stop flashing. Press the SET key to switch on or off the alarm. (The showing of the icon [((•))] means that the alarm is switched on.)
4. Press the ALARM key once to return to the normal display mode.

In case the wind speed exceeds the condition for high wind speed alarm, the value will be flashing, along with the corresponding high alarm icon ("HI AL"). And the buzzer will ring for two minutes. User may press any key to stop the sound.

### **HYSTERESIS**

To compensate for fluctuation of the measured data, which may cause the weather alarm to sound constantly if the measured reading is close to your set level, a hysteresis function has been implemented for each weather alarm. For example, if the high temperature alarm is set to +25°C and the current value moves to +25°C, the alarm will be activated (if it has been enabled). Now when the temperature drops to +24.9°C or below and thereafter again increases to beyond +25°C, the data will be blinking, but no alarm will be activated. It has to drop to below +24°C (with a pre-set hysteresis of 1°C) so that the alarm can be produced again. Hysteresis values for the various weather data types are given in the following table:

<b>Weather data</b>	<b>Hysteresis</b>
Temperature	1°C
Humidity	3% RH
Wind speed	5 km/h

**Note:**

The temperature or humidity data will keep on flashing even after a key has been pressed to stop the alarm or buzzer has been switched off, to indicate that the current weather condition is out of the pre-set limit(s)

## WEATHER FORECAST AND WEATHER TENDENCY:

### WEATHER FORECASTING ICONS:

Weather forecasting icons is displayed in any of the following combinations at the right bottom part of LCD:

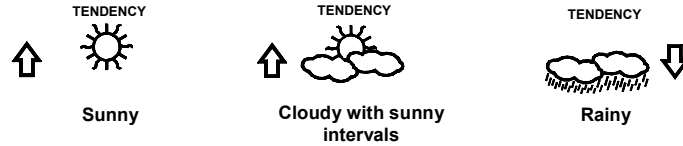

For every sudden or significant change in the air pressure, the weather icons will update accordingly to represent the change in weather.

(Every time a new average pressure value has been obtained [once per minute], this value is compared with an internal reference value. If the difference between these values is bigger than the selected weather tendency threshold, the weather-icon changes, either for worse or for better. In this case, the current pressure value becomes the new weather tendency reference.)

If the icons do not change, then it means either the air pressure has not changed or the change has been too small for the Weather station to register. So you may adjust the "sensitivity" of the pressure change checking in the setting mode – see **WEATHER TENDENCY THRESHOLD VALUE SETTING** above.

However, if the icon displayed is a sun or raining cloud, there will be no change of icon if the weather gets any better (with sunny icon) or worse (with rainy icon) since the icons are already at their extremes.

The icons displayed forecasts the weather in terms of getting better or worse and not necessarily sunny or rainy as each icon indicates. For example, if the current weather is cloudy and the rainy icon is displayed, it does not mean that the product is faulty because it is not raining. It simply means that the air pressure has dropped and the weather is expected to get worse but not necessarily rainy.

**Note:**

After setting up, readings for weather forecasts should be disregarded for the next 12-24 hours. This will allow sufficient time for the Weather station to collect air pressure data at a constant altitude and therefore result in a more accurate forecast.

Common to weather forecasting, absolute accuracy cannot be guaranteed. The weather forecasting feature is estimated to have an accuracy level of about 75% due to the varying areas the Weather station has been designed for use. In areas that experience sudden changes in weather (for example from sunny to rain), the Weather Station will be more accurate compared to use in areas where the weather is stagnant most of the time (for example mostly sunny).

If the Weather station is moved to another location significantly higher or lower than its initial standing point (for example from the ground floor to the upper floors of a house), discard the weather forecast for the next 12-24 hours, as the Weather Station may mistake the new location as being a possible change in air-pressure when really it is due to the slight change of altitude.

**WEATHER TENDENCY INDICATOR**

Working together with the weather icons is the weather tendency indicators (arrow located on the left and right sides of the weather icons). When the indicator points upwards, it means that the air-pressure is increasing and the weather is expected to



improve, but when indicator points downwards, the air-pressure is dropping and the weather is expected to become worse.

Taking this into account, one can see how the weather has changed and is expected to change. For example, if the indicator is pointing downwards together with cloud and sun icons, then the last noticeable change in the weather was when it was sunny (the sun icon only). Therefore, the next change in the weather will be cloud with rain icons since the indicator is pointing downwards.

**Note:**

Once the weather tendency indicator has registered a change in air pressure, it will remain permanently visualized on the LCD.

**AIR PRESSURE HISTORY (ELECTRONIC BAROMETER WITH BAROMETRIC PRESSURE TREND)**

The bottom section of the LCD also shows the relative air pressure value and the air pressure history.

Depending on programming conditions, display of the history of air pressure in form of a graph consisting of vertical bars.

The bar graph of the electronic barometer shows the air pressure history of the past 12 hours in five three-hour steps.

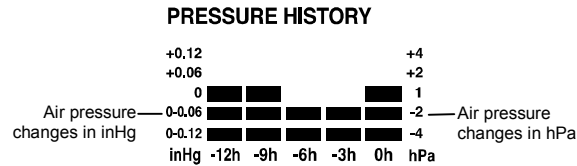

The horizontal axis represents the last 12 hours air pressure recording (-12, -9, -6, -3 and 0 hour). The bars are plotted at each of the five steps and give the trend over the recorded period. The scale on the right compares the result. The "0" in the middle of this scale determines the current air pressure.

The vertical axis represents the air pressure changes in hPa (+4, +2, 0, -2, -4. "0" represents the current air pressure). The newly measured pressure was compared to the previously recorded pressure reading. The pressure change is expressed by the difference between the current ("0h") and the past readings in division of  $\pm 2$  hPa or  $\pm 0.06$  inHg. If the bars are rising it indicates that the weather is getting better due to an increase in air pressure. If the bars go down it indicates a drop of the air pressure and the weather is expected to get worse from the present time "0". At every full hour the current air pressure is used as a basis for the display of a new graph bar. The existing graph is then moved one column to the left.

**Note:**

For accurate barometric pressure trend, the Weather Station should operate at the same altitude. For example, it should not be moved. Should the unit be moved, for instance from the ground to the second floor of the house, the readings for the next 12-24 hours shall be discarded.

**WIND DIRECTION AND WIND SPEED MEASUREMENT**

In normal display mode, the second section of the LCD shows the following wind data.

- Wind direction (shown on the a compass scale of 16 divisions) and wind speed in Beaufort scale
- Wind chill in °C or °F
- Wind Speed in km/h, mph or m/s

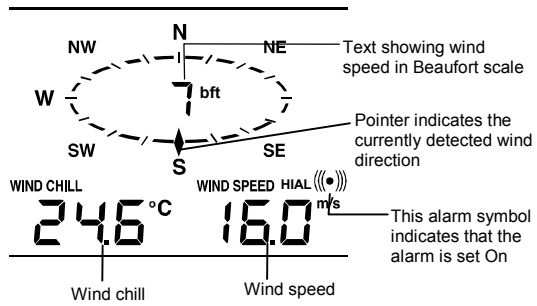

**RAINFALL MEASUREMENT**

The total rainfall measurement is displayed in the fourth section of the LCD, in the unit of mm or inch. (see **VIEWING THE MAXIMUM/ MINIMUM WEATHER DATA** below)

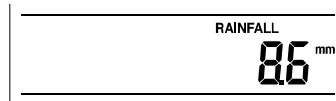

#### **VIEWING THE HISTORY DATA**

The weather station can store up to 200 sets of weather data which are recorded automatically at three-hour intervals after the weather station is powered up, at the nearest time of 0:00, 03:00, 06:00, 09:00, 12:00, 15:00, 18:00 and 21:00. For instance, if user has manually set the time as 14:52 after installing batteries, the first history record will be made at the coming 15:00 automatically. Then the second record will be on 18:00 and so on.

Each weather record includes the Wind direction, Wind speed in Beaufort scale, Wind chill temperature, wind speed, Outdoor temp and humidity, relative pressure and total rainfall, pressure history and weather tendency. Also, the time and date of recording will be displayed.

#### **Note:**

In order to acquire the correct time of recording of the history records, you shall manually set the current time as soon as installing batteries to the weather station. Afterwards, you should avoid changing the pre-set time as it will also alter the recorded "time of recording" of each history record, which may lead to confusion.

#### **To view the weather history:**

1. Press the HISTORY key. The latest weather record will be shown with the date and time of recording. The "HISTORY" icon will be displayed at the bottom of the LCD.

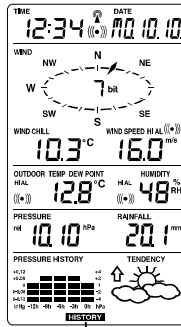

HISTORY icon

2. Press MIN/ MAX to view older records.  
(Press MIN/MAX and + key to view "Previous" and "Next" record respectively.  
The records are made at three-hour intervals.)

**Note:**

- The stored history records will not be retained after battery change or whenever battery is removed.
- The total rainfall value will be exhibited in whole number (no decimal place) in the history record.

### VIEWING THE MAXIMUM/ MINIMUM WEATHER DATA

The weather station will record the maximum and minimum value of the various weather data with time and date of recording automatically. The following stored maximum and minimum weather data can be viewed by pressing the MIN/MAX key in normal display mode.

#### 1. Min outdoor temperature with the date and time of recording

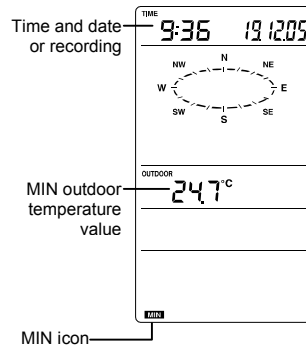

2. Max outdoor temperature with the date and time of recording
3. Min outdoor humidity with the date and time of recording

4. Max outdoor humidity with the date and time of recording

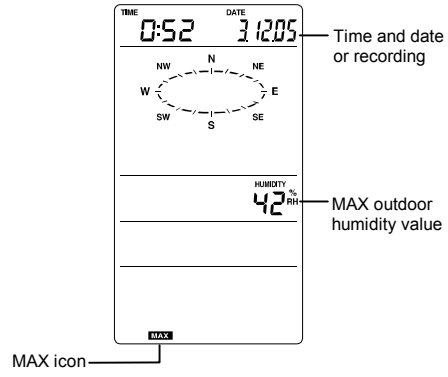

5. **Min Wind chill temperature with the date and time of recording**

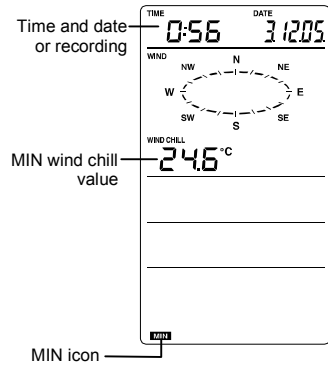

- 6. **Max Wind chill temperature with the date and time of recording**
- 7. **Min Relative pressure with the date and time of recording**



8. Max Relative pressure with the date and time of recording

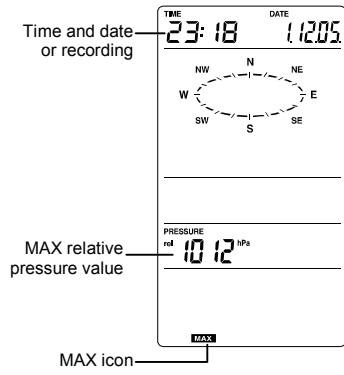

## 9. Maximum wind speed

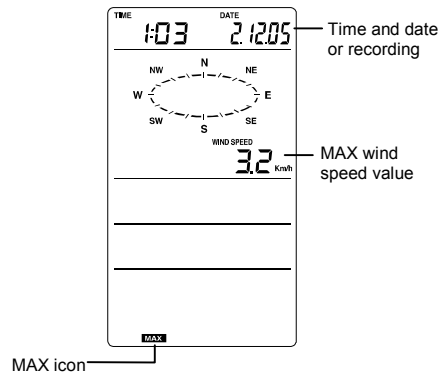

### RESET THE MAXIMUM AND MINIMUM WEATHER DATA

To reset the aforementioned maximum or minimum weather data 1. to 9., you shall need to reset each of the data independently.

1. Press MIN/MAX key to show the desired weather data. For instance, if you want to reset the minimum humidity, in the normal display you shall press the MIN/MAX key three times to show the min humidity value.
2. Press and hold the SET key for about two seconds, then the "RESET" icon will appear at the bottom part of the LCD.

3. Press the + key once, then the stored value will be reset to the current value and current time.
4. Press the ALARM key to return to normal display mode.

**10. Total rainfall amount**

The total rainfall measurement is displayed in the fourth section of the LCD, in the unit of mm or inch. It shows the total rainfall accumulated since last reset of the weather station.

In normal display mode, press the MIN/MAX key ten times to show the total rainfall value. The "RESET" icon will also be shown at the same time.

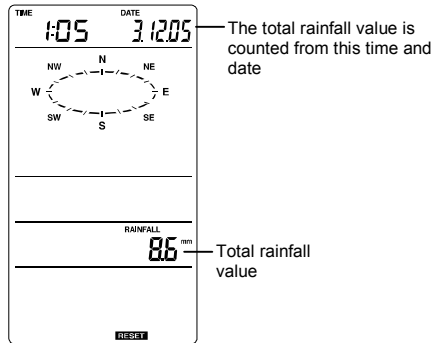

To reset the rainfall reading, press the + key once when the Rainfall value and "Reset" icon is shown. Then the total rainfall amount will be reset to zero, and the time updated to current time.

**Note:**

After power up, the time and date and total rainfall is displayed as "- - -". After time is adjusted manually, the set time will be shown.

**SWITCHING ON/OFF THE BUZZER**

User may choose to turn off the buzzer so that when the time alarm is switched on and activated, the buzzer will not sound but we can still see the alarm icon (((•))) flashing on the LCD for time alarm.

On the other hand, when the buzzer is turned off and any weather alarm is activated, the particular weather digits will flash to show user that the weather condition is being out of the preset threshold value, yet the buzzer will not sound.

To switch off the buzzer:

1. In normal display mode, press and hold the SET key until the icon "BUZZER OFF" is shown at the right side above the Wind direction scale. The LCD will change to setting mode.
2. Press ALARM key once to return to the normal display mode. The "BUZZER OFF" icon will still be shown.



To re-enable the buzzer:

1. When the "BUZZER OFF" icon is shown on LCD, press the SET key shortly and the "BUZZER OFF" icon will disappear.
2. Press ALARM key once to return to the normal display mode. The "BUZZER OFF" icon will no longer be shown. Then the alarm will sound normally.

#### **LOW BATTERY INDICATOR**

The low battery indicator of the weather station and the transmitter will be displayed at the top and bottom portion of the LCD respectively when the battery power is low. It is recommended to replace the batteries in all units on an annual basis to ensure optimum accuracy of the system.

#### **Note:**

- After battery change, both the Weather Station and the transmitters need to be reset (see note **SETTING UP**)
- The History data record will be clear after the battery change.

#### **OUTDOOR TRANSMITTER 868 MHz RECEPTION CHECK**

The outdoor temperature, humidity, wind data and rainfall is transmitted from transmitter every 4.5 seconds and the receiver will be synchronized to the transmitter to receive outdoor data then. The transmission range (supposedly up to about 100 metres) of the Outdoor Thermo-hygro transmitter may be affected by the ambient temperature. At cold temperatures the transmitting distance may be decreased. Please keep this in mind when placing the transmitter.

If the outdoor data are not being received within 30 seconds after setting up (or the outdoor display show "--" in the outdoor section of the Weather Station after

consecutive failed attempts during normal operation), please check the following points:

1. The distance of the Weather Station or transmitter should be at least 1.5 to 2 metres away from any interfering sources such as computer monitors or TV sets.
2. Avoid positioning the Weather Station onto or in the immediate proximity of metal doors or window frames.
3. Using other electrical products such as headphones or speakers operating on the same signal frequency (868 MHz) may prevent correct signal transmission and reception.
4. Neighbours using electrical devices operating on the 868 MHz signal frequency can also cause interference.
5. "Visibility" of weather station and transmitter (e.g. through a window) increases the range.

**Note:**

When the 868 MHz signal is received, do not re-open the battery compartment cover of either the transmitter or Weather Station, as the batteries may spring free from the contacts and force a false reset. Should this happen accidentally then reset all units (see **SETTING UP** above) otherwise transmission problems may occur.

During normal operation, after the outdoor display shows "- - -", the weather station will change to receive the outdoor data every 15 minutes, until the data is read. Then the reception period will return to 4.5 seconds.

If no reception is possible despite the observation of these factors, all system units have to be reset (see **SETTING UP**).

**POSITIONING:**

Prior to permanently affixing any of the units, please ensure the following points are considered:

- Cable lengths of the units meet with your distance requirements at the point of fixing
- Signals from the sensors can be received by the base station at points of mounting

**The Weather Station**

The Weather Station has been designed to be hung onto wall or free standing with the two kinds of foldout stand.

**To wall mount**

Choose a sheltered place. Avoid direct rain and sunshine.

Before wall mounting, please check that the outdoor temperature and humidity values can be received from the desired locations. To wall mount:

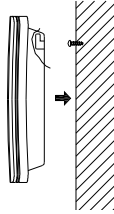

1. Fix a screw (not supplied) into the desired wall, leaving the head extended out the by about 5 mm.
2. Hang the station onto the screw. Remember to ensure that it locks into place before releasing.

### The Thermo-hygro Sensor

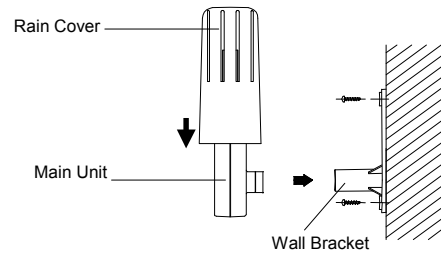

An ideal mounting place for the thermo-hygro sensor would be the outer wall beneath the extension of a roof, as this will protect the sensor from direct sunlight and other extreme weather conditions.

To wall mount, use the two screws to affix the wall bracket to the desired wall, plug in the thermo-hygro sensor to the bracket and secure both parts by the use of the supplied screw and ensure that the cables from the wind and rain sensors are correctly plugged in otherwise data transmission errors could occur.



### The Wind Sensor

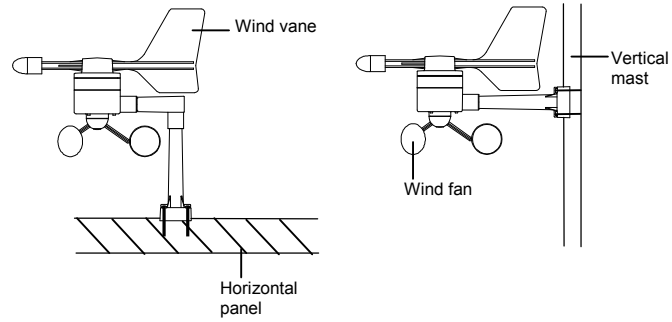

Firstly, check that the wind-fan and the wind-vane can rotate freely before fixing the unit. For correct and accurate readings it is important to mount the sensor so that the front (marked E) is pointing in East-West direction. The wind sensor should now be mounted using the screw or cable tie provided onto a solid wall/ panel mast or mast to allow the wind to travel around the sensor unhindered from all directions (ideal mast size should be from diameter 16 mm to 33 mm).

Once the wind sensor is fixed onto the mast, connect the cable to the corresponding thermo-hygro sensor socket so that operating power supply can be received and data can be transmitted to the base station.

## The Rain Sensor

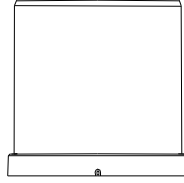

For best results, the rain sensor should be securely mounted onto a horizontal surface about one meter above the ground and in an open area away from trees or other coverings where rainfall may be reduced causing inaccurate readings.

When securing into place, check that rain excess will not collect and store at the base of the unit but can flow out between the base and the mounting surface (testing by pouring clean water).

After mounting the rain sensor, connect the cable to the thermo-hygro sensor at the corresponding socket so power supply can be received and data be transmitted to the base station.

The rain sensor is now operable. For testing purposes, very slowly pour a small amount of clean water into the rain sensor funnel. The water will act as rainfall and will be received and displayed at the base station after about two minutes delay i.e. when the reading interval is reached.

**CARE AND MAINTENANCE:**

- Extreme temperatures, vibration and shock should be avoided as these may cause damage to the units and give inaccurate forecasts and readings.
- When cleaning the display and casings, use a soft damp cloth only. Do not use solvents or scouring agents as they may mark the LCD and casings.
- Do not submerge the units in water.
- Immediately remove all low powered batteries to avoid leakage and damage. Replace only with new batteries of the recommended type.
- Do not make any repair attempts to the units. Return it to their original point of purchase for repair by a qualified engineer. Opening and tampering with the units may invalidate their guarantee.
- Do not expose the units to extreme and sudden temperature changes, this may lead to rapid changes in forecasts and readings and thereby reduce their accuracy.

**SPECIFICATIONS:**

Temperature measuring range:

Outdoor : -40°C to +59.9°C with 0.1°C resolution  
-40°F to +140°F with 0.2°F resolution  
("OF.L" displayed if outside this range)

Relative humidity measuring range:

Outdoor : 1% to 99% with 1% resolution  
("-" displayed if < 1%, "99" displayed if ≥ 99%)

Wind speed : 0 to 50 m/s (0 to 111.8 mph)  
 (displayed "OF.L" when > 50 m/s)  
 Wind chill : -40°C to +59.9°C (-40°F to +140°F)  
 (displayed "OF.L" if outside this)  
  
 Relative pressure pre-set range : 919 to 1080 hPa (27.17 to 31.90 inHg)  
 Rainfall : 0 to 9999 mm (0" to 393.6") (displayed  
 "OF.L" when > 9999 mm)  
  
 Outdoor data reception : every 4.5 seconds  
 Air pressure checking interval : every 15 seconds  
 Transmission range : up to 100 meters in open space  
  
 Power:  
 Weather Station : 3 x AA, IEC LR6, 1.5V  
 Thermo-hygro transmitter : 2 x AA, IEC LR6, 1.5V  
 Battery life : approximately 12 months (Alkaline batteries  
 recommended)

Dimensions (L x W x H):  
 Weather Station : 165.4 x 30.8 x 141.9 mm  
 Thermo-hygro transmitter : 57.3 x 62 x 157 mm  
 Wind sensor : 250 x 164 x 192.7 mm  
 Rain sensor : 140 x 70 x 137 mm

**LIABILITY DISCLAIMER**

- The electrical and electronic wastes contain hazardous substances. Disposal of electronic waste in wild country and/or in unauthorized grounds strongly

- damages the environment.
- Please contact your local or/and regional authorities to retrieve the addresses of legal dumping grounds with selective collection.
- All electronic instruments must from now on be recycled. User shall take an active part in the reuse, recycling and recovery of the electrical and electronic waste.
- The unrestricted disposal of electronic waste may do harm on public health and the quality of environment.
- As stated on the gift box and labeled on the product, reading the "User manual" is highly recommended for the benefit of the user. This product must however not be thrown in general rubbish collection points.
- The manufacturer and supplier cannot accept any responsibility for any incorrect readings and any consequences that occur should an inaccurate reading take place.
- This product is designed for use in the home only as indication of the temperature.
- This product is not to be used for medical purposes or for public information.
- The specifications of this product may change without prior notice.
- This product is not a toy. Keep out of the reach of children.

#### **WASTE DISPOSAL**

This product has been manufactured using high-grade materials and components which can be recycled and reused.



Never throw flat batteries and rechargeable batteries in household waste.

As a consumer, you are legally required to take them to your retail

store or to appropriate collection sites according to national or local regulations in order to protect the environment.

The symbols for the heavy metals contained are: Cd=cadmium, Hg=mercury, Pb=lead



This instrument is labelled in accordance with the EU Waste Electrical and Electronic Equipment Directive (WEEE). Please do not dispose of this product with other household waste. The user is obligated to take end-of-life devices to a designated collection point for the disposal of electrical and electronic equipment, in order to ensure environmentally-compatible disposal.

TFA Dostmann GmbH & Co. KG, Zum Ottersberg 12, D - 97877 Wertheim

No part of this manual may be reproduced without written consent of TFA Dostmann. The technical data are correct at the time of going to print and may change without prior notice.

**DECLARATION OF CONFORMITY**

Herewith we declare, that this wireless transmission device does comply with the essentials requirements of R&TTE Directive 1999/5/EC.

A copy of the signed and dated Declaration of Conformity is available on request via

[info@tfa-dostmann.de](mailto:info@tfa-dostmann.de).

[www.tfa-dostmann.de](http://www.tfa-dostmann.de)

06/12